

Shenzhen Arashi Vision Co., Ltd.

Insta360™ Pro

QUICKSTART GUIDE + PRODUCT INTRODUCTION

English · 简体中文 · 繁體中文 · 日本語 · 한국어 · Deutsch · Français · Italiano · Español · Русский · Português · العربية

1 Insta360 Pro Panoramic Camera

1.1 Insta360 Pro Overview

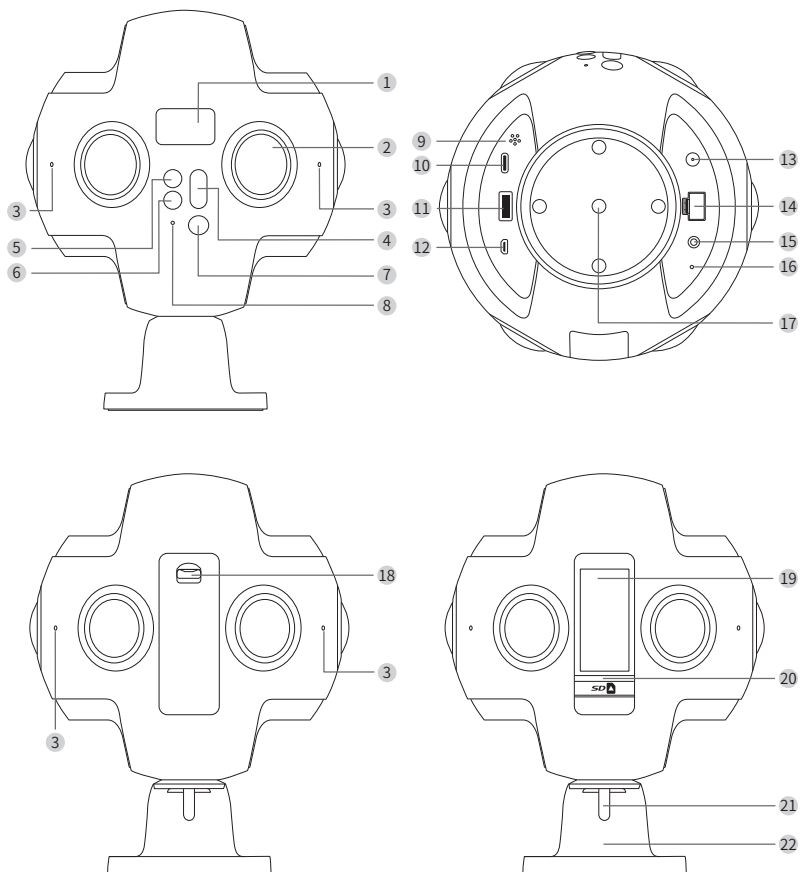

- | | | | |
|----|---|----|-----------------------------|
| 1 | OLED Display screen | 12 | HDMI 2.0 Type D interface |
| 2 | Lens | 13 | DC Power interface |
| 3 | Microphone and indicator for working status | 14 | LAN interface |
| 4 | Switch key | 15 | 3.5mm Audio input interface |
| 5 | Return key | 16 | Reset pinhole |
| 6 | Setting key | 17 | Standard 1/4 bolt |
| 7 | Power/Enter key | 18 | Battery cover button |
| 8 | Indicator for power status | 19 | Battery slot |
| 9 | Speaker | 20 | SD card slot |
| 10 | USB Type-C interface | 21 | Bolt |
| 11 | USB 3.0 interface | 22 | Fixed base |

1.2 Specifications

Items	Parameters
Lens	200° F2.4 Fish-eye lens
Max. resolution of single picture	4000 x 3000 (Real-time stitching of 8K/3D panoramic pictures at maximum)
Max. resolution of single video in 360° panoramic mode	3840 x 2160 (Stitching of 8K panoramic video at maximum)
Max. resolution of single video in 360° 3D mode	3200 x 2400 (Stitching of 6K panoramic 3D video at maximum)
Compatible storage media	SD card of standard V30 speed or above/ USB 3.0 mobile hard disk
Input	12 V / 5 A
Weight (with battery)	About 1.25 kg
Dimensions	φ143 mm

2 Preparations Before Use

① Before using the camera, please insert the rechargeable lithium polymer battery. Please connect the adapter in case of low battery or battery depleted.

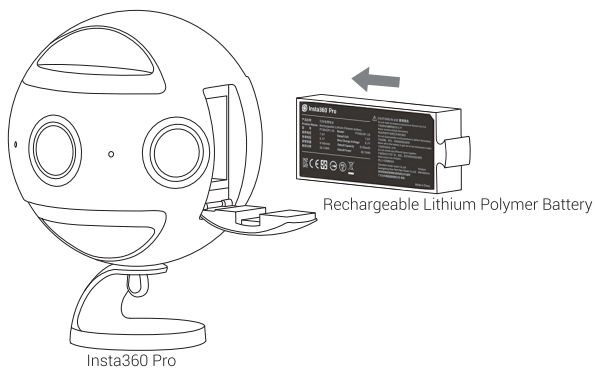

② Before using the camera, please insert a SD card which is in exFAT format and has a speed of standard **V30** or above, or connect an external USB 3.0 mobile hard disk (SSD mobile hard disk is recommended).

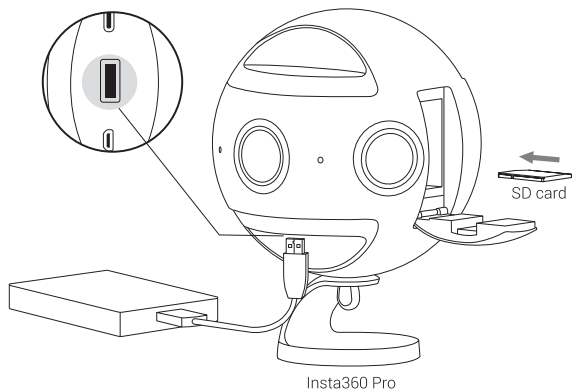

Note: After the camera has accessed the USB 3.0 mobile hard disk, the mobile hard disk will be the default storage path of the shooting files.

3 Remote Connection

After the camera accesses to a wired/wireless network, it can be controlled by the control software remotely.

3.1 Wired Connection

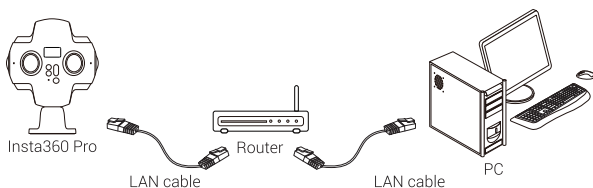
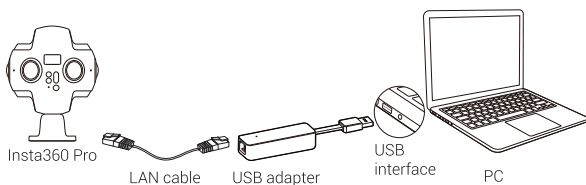

3.2 Wireless Connection

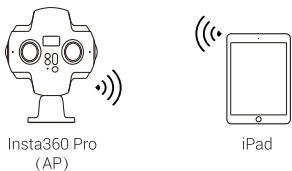
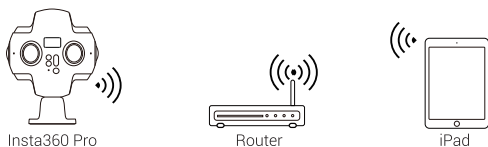

4 Data Transmission

Access the camera to a computer by a USB Type-C cable to view photos and videos via the corresponding player from the software kit. The player can be downloaded at <http://www.insta360.com/download/insta360-other>.

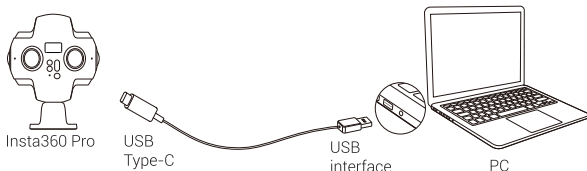

5 More Information

Insta360 Pro will keep rolling out new features. To get more detailed information and the user guide, please visit <https://www.insta360.com/r/pro-tutorial>.



Scan to learn more
about the product

*Notice of further updates of this manual will not be issued.

Certification



This device complies with part 15 of the FCC Rules. Operation is subject to the following two conditions: (1) This device may not cause harmful interference, and (2) this device must accept any interference received, including interference that may cause undesired operation.

Product Name(产品名称): Insta360 Pro Panoramic Camera

Model No.(型号): TINPPRO/A

DC Rating(直流电源): DC 12V \pm 5A

FCC ID : 2AFSH-TINPPRO-A

Manufacturer : Shenzhen Arashi Vision Company Limited

深圳岚锋创视网络科技有限公司

Made in China 中国制造



Use only power supplies listed in the user manual



CONTACT US

Shenzhen Arashi Vision Company Limited

TEL (+86) 400-833-4360
EMAIL service@insta360.com
WEB www.insta360.com
ADD 6/F, Building A, Logan Century Center, 23 Haixiu Road,
Bao'an District, Shenzhen, China

